

Article number: 204260M840A1S

Description: E+G levelling foot  
GN 42-60-M8-40-A1-S

Note: S Without nut, External hexagon at the bottom

## Measures

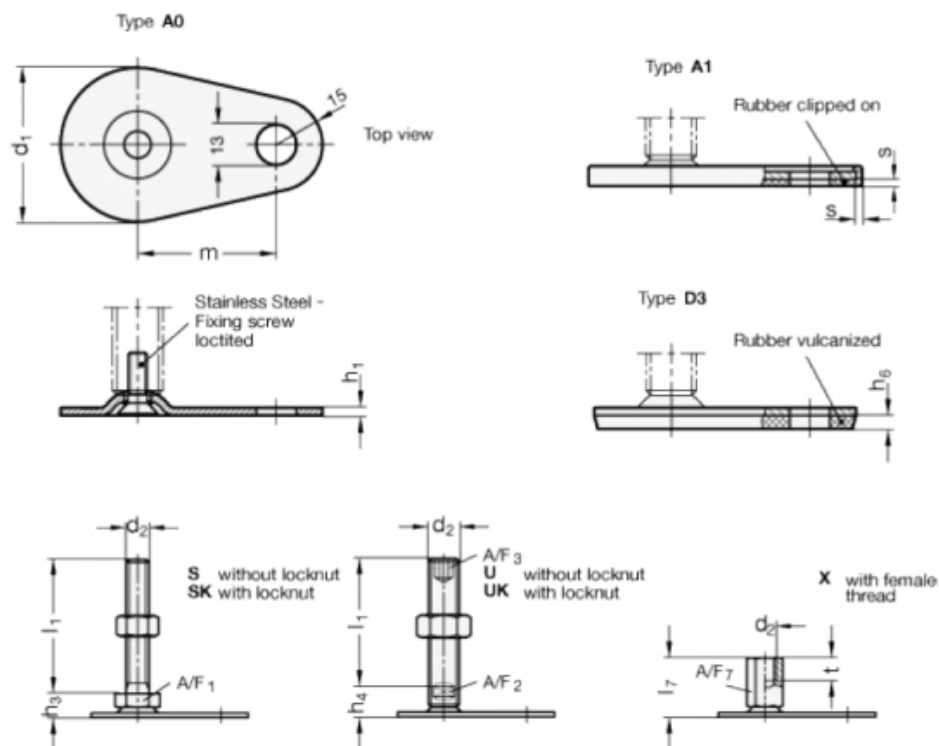

A/F1 = 17	s = 2
d1 = 60	
d2 = M8	
h1 = 2.5	
h3 = 11	
h6 =	
l1 = 40	
m = 50	